



Energy Management Control System

Author: Hakan YILDIRIM
Saveplug Inventor

INTRODUCTION

This application note describes an electronic system to improve the efficiency of certain types of single-phase induction motors.

The system is based around the **EMC** - an energy management controller IC for induction motors. This CMOS device is based on **Saveplug's** RISC processor core and proprietary firmware algorithms. When combined with some external analog components, the **EMC** will provide an electronic system that economically reduces the operating costs of small induction motors by as much as 58%. It will also allow motors to run cooler and with less vibration. The system operates on single phase 110 or 240 VAC.

FIGURE 1: SYSTEM BLOCK DIAGRAM

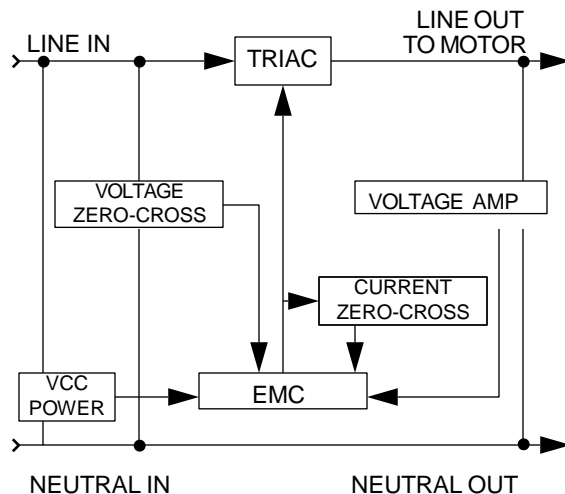

RECOMMENDED APPLICATION

The schematic diagram shown in Figure 11 is a recommended circuit. See Table 3 for the parts list. It uses low cost, readily available components. Note that Vcc is supplied directly from the AC line without the need for a transformer. Component values have been calculated to work on 110 or 240 VAC lines, with motor current draws of up to 15A RMS continuous. This translates to 1 to 1.5 HP at 110V, and 3 HP at 220V. Motor size can be increased by selecting a triac with a larger current rating.

This system will only work with rotating inductive loads (i.e., motors) that are not otherwise power-factor corrected -- will not function with this system, nor will fluorescent lighting. Universal motors (brush-type) will not benefit from the system, either. While use of this system will usually save energy, the greatest savings will be for lightly-loaded motors.

For best results, appliances or systems with other electrical devices in addition to motors should have those devices powered directly from the line, not through the energy management control system (**EMC**).

Also, note that each motor must have its own control circuit (unless the motors are never activated at the same time).

The circuit can be laid out on a single- or double-sided board, observing the standard layout techniques used with monolithic microcontrollers. LED D3 is lighted during normal operation of the **EMC**, and can be left out of the circuit, if desired.

Heatsinking of the triac will be required, the size depending on the triac rating, the motor current draws and ambient temperatures.

The distance between the motor and the **EMC** circuit is not critical.

Standard electrical practices should be followed. Agency approvals may be required, depending on the implementation. While this circuit should not be connected to earth ground, any enclosure should be so connected. Also note that the low voltage power generated on this board should not be used to supply any other circuitry, particularly if that circuitry is off the board.

THEORY OF OPERATION

Power Consumption

In an induction motor, the current draw at no load is quite high because the stator windings must supply all the magnetic field energy. This means that, even when idling, the motor draws a major portion of its full-load current. The energy not converted into work is converted into heat and vibration. In addition to being wasted, the heat and vibration shortens the life of lubricants, bearings, and other components in the vicinity.

The torque produced by an AC motor is proportional to the square of the applied voltage. Thus, a motor producing part of its rated load only needs part of its rated voltage.

Power Factor

In an induction motor, the current in the windings lags the voltage, due to the inductive reactance in the windings (Figure 10). The cosine of the amount of lag in degrees is the power factor. Power factors are 1.0 for resistive loads (heaters, etc.) and vary from close to 1 for a fully loaded motor, to as low as 0.1 for an idling motor. The actual power being consumed by the motor is:

$$(\text{Voltage}) \bullet (\text{Current}) \bullet (\text{Power Factor})$$

A lightly loaded induction motor has low power factor. As the motor reaches its rated load, its power factor gets closer to 1. How close it gets to 1 will depend on the motor's internal design. Values around 0.65 are typical of single-phase motors.

The **EMC** System calculates motor loading by measuring the time between current and voltage zero-crossings, in effect, power factor. When the load on the motor is low, the power consumed by the motor can be lowered by lowering the voltage applied to the motor, which is done by turning a triac on at the proper time during the voltage cycle. (Figure 10 for waveforms.) The resulting voltage across the motor, and the zero-crossing times, are monitored, and adjusted on a cycle-by-cycle basis, as determined by the proprietary algorithms in the **EMC**. At no load, the voltage to the motor can be as low as 85 VAC, instead of the usual 120 VAC. Power consumption can be cut by as much as 58%, depending on load, and operating temperature lowered by as much as 45°F. Refer to the system block diagram in [Figure 1](#), and the graph in [Figure 2](#) and [Table 1](#).

A motor powered by the **EMC** and this energy management control circuit will draw less current. Its power factor will also be improved; however, the power factor seen by the line will NOT be improved.

ENERGY MEASUREMENT

To measure the true power of an induction motor requires the use of a true-RMS power meter, one that will measure non-sinusoidal waveforms. Models of this type of instrument are available from Fluke and Tektronix, among others.

Measurements for this Application Note were made using the following equipment:

Hampden Engineering Corp:

CSM-100 1/3 HP Split
Phase motor
(110-VAC / 60Hz)

DYN-100A Dynamometer

RI-100A Load bank

HPT-100 Digital Photo Tachometer

Tektronix Corp:

THM560 Scopemeter
A622 Current probe

The voltage, current, and true-RMS power supplied to the Energy Management Control System driving a 1/3 HP motor were measured with the meter and current probe. The motor RPM was measured with the photo-tach. The torque supplied by the motor was measured with the dynamometer, which also supplied the adjustable load on the motor.

Motor Power Out in Watts is calculated by:

$$P=(\tau n)/5.18$$

Power Out in Horsepower is calculated by:

$$P=(\tau n)/7142.72$$

τ is in Newton-meters

n is RPM

Efficiency, in percent (%), is calculated by:

$$(\text{Power Out})/(\text{Power In}) \bullet 100$$

CIRCUIT DETAILS

The **EMC** consists of a high-performance 8-bit microcontroller (U3) with embedded proprietary algorithms, which monitors the voltage across the motor (U1), the voltage zero-crossing (Q2) and the current zero-crossing (by monitoring the signal on Q3). By measuring the time between voltage and current zero-crossings, it calculates the amount of load on the motor.

U1 and R10-R13 form a differential amplifier with a gain of 1/48. C4 limits noise sensitivity.

C2 through C6 and components in between rectify and filter line voltage to provide Vcc.

Q1 and associated components provide power-up reset for the **EMC**.

L1 and C8 form an LC filter for the 5V power supply.

U2 is an opto-triac to trigger the power triac. Q3 is the triac, which in this circuit is rated at 15A.

D3 and R7 are used to indicate "normal operation" of the circuit, and may be left out if desired.

As stated above, it turns out that the energy consumption of a motor running only partly loaded can be lowered by decreasing the current flowing into the motor windings. This can be accomplished by lowering the voltage across the motor windings. If the voltage is not increased when the motor load increases, the internal reactance of the motor decreases, and the windings will draw too much current, and could overheat and be damaged. Because the **EMC** is an intelligent controller, it is able to monitor motor voltage and motor load, and make corrections within 8 ms, well before there is any potential for motor damage.

See Figure 10 for circuit waveforms.

ENERGY SAVINGS

Reducing the voltage to the motor cuts its power draw. By reviewing [Table 1](#), it can be seen that at no load, the 1/3 HP test motor is dissipating 120W, much of it as heat. With the **EMC** managing the power load, this drops to 50W, a savings of 58%. At full load, the figures are, respectively, 428W and 406W, for a savings of 5%. The degree of savings are presented in [Table 2](#).

This data is presented graphically in the following figures.

Actual performance figures may vary based on motor size, motor load and motor construction.

FIGURE 2: ENERGY SAVINGS

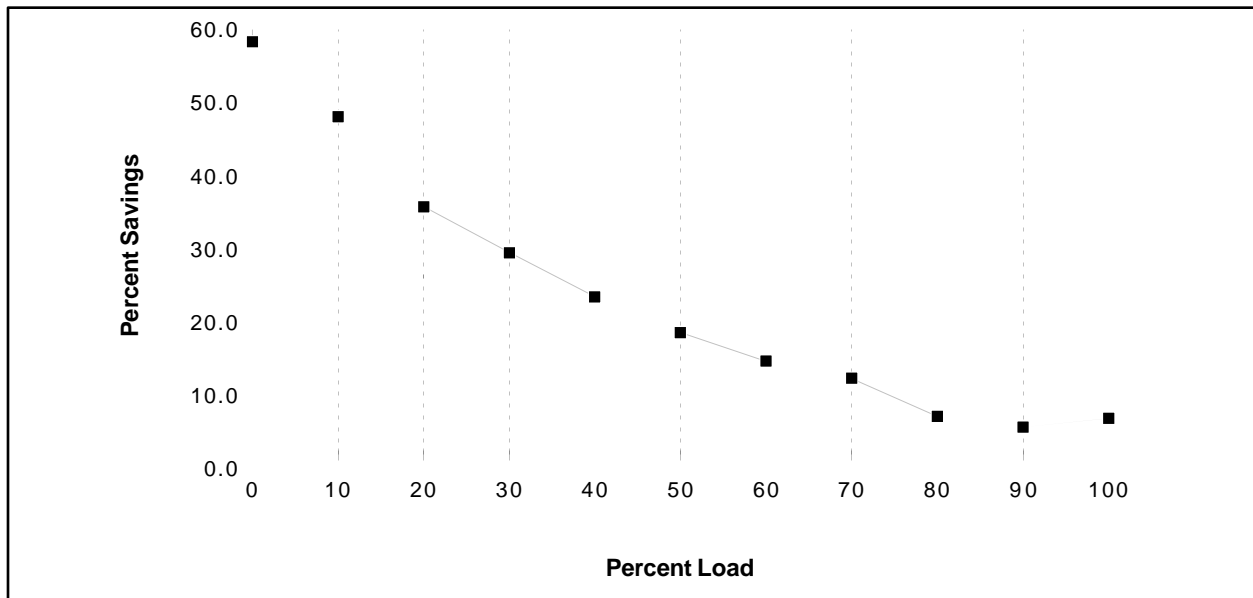

FIGURE 3: MOTOR SPEED CHANGE

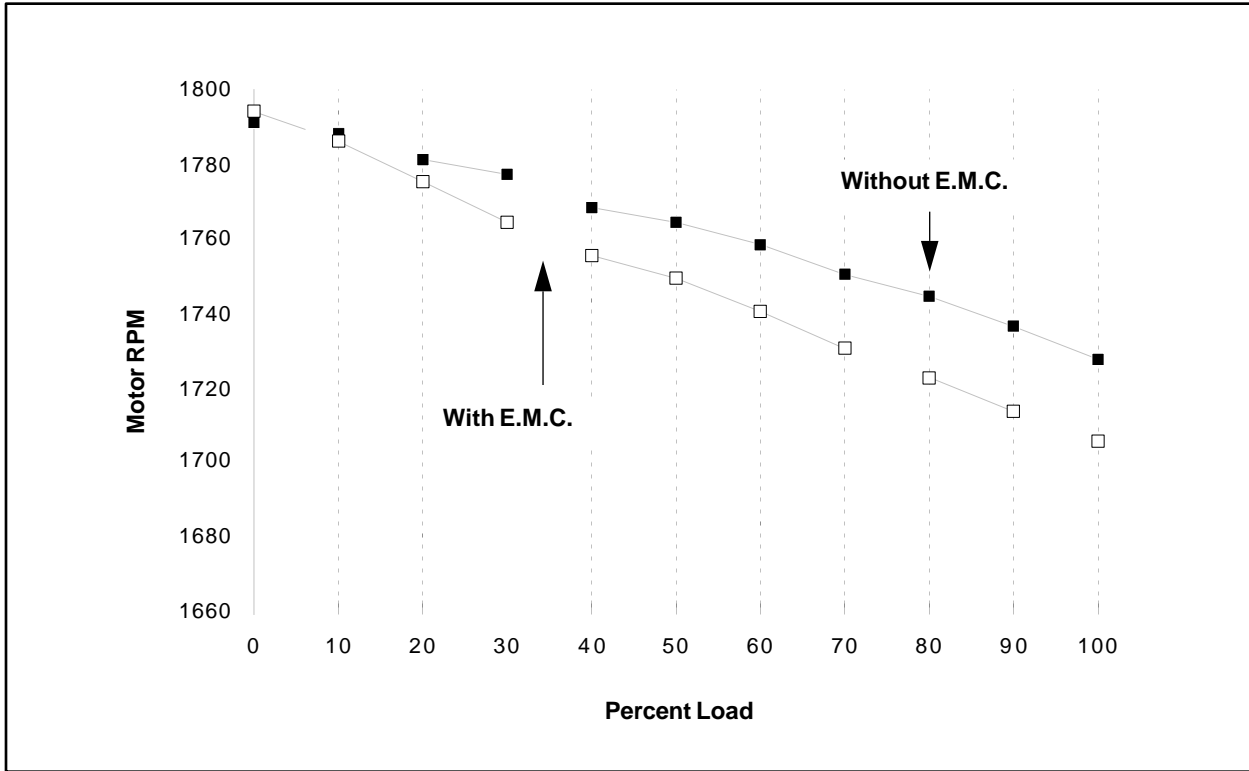

FIGURE 4: MOTOR EFFICIENCY

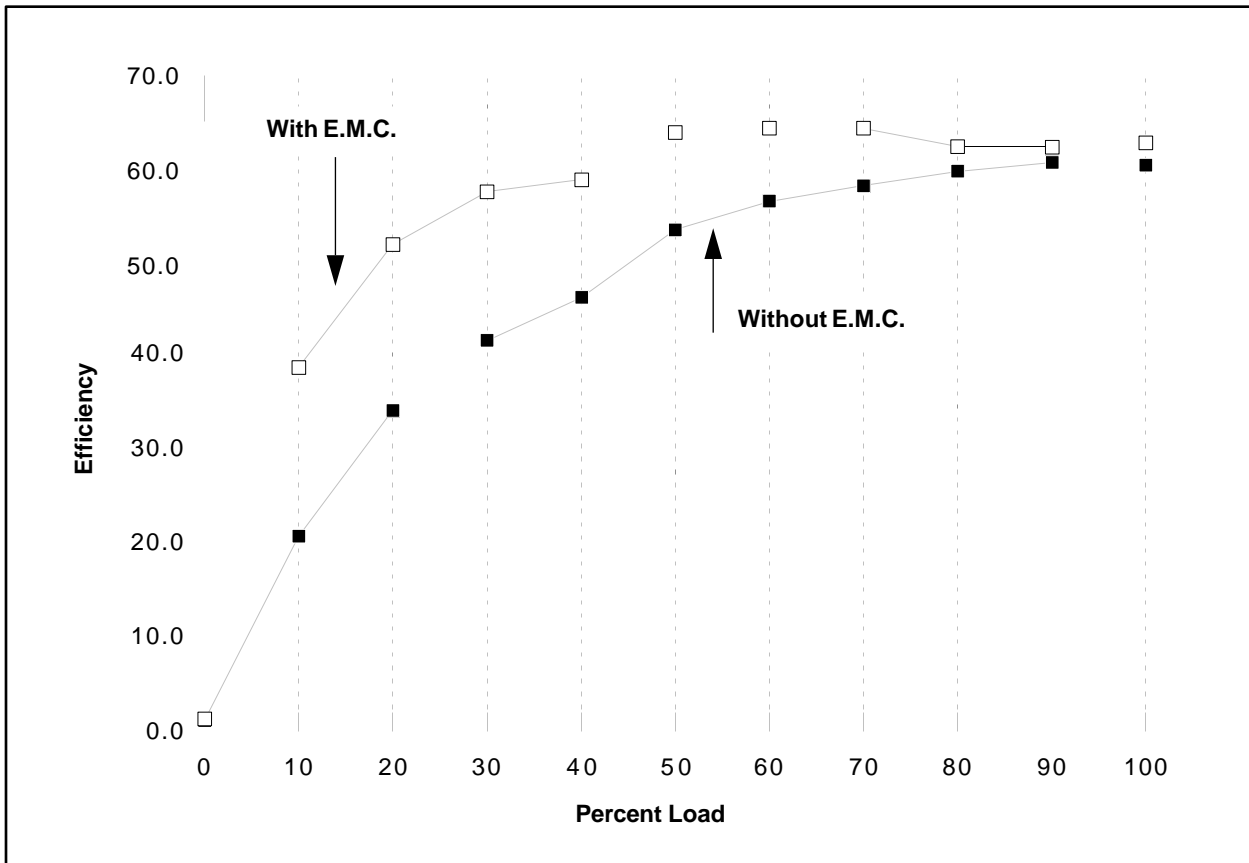

FIGURE 5: EFFICIENCY IMPROVEMENT

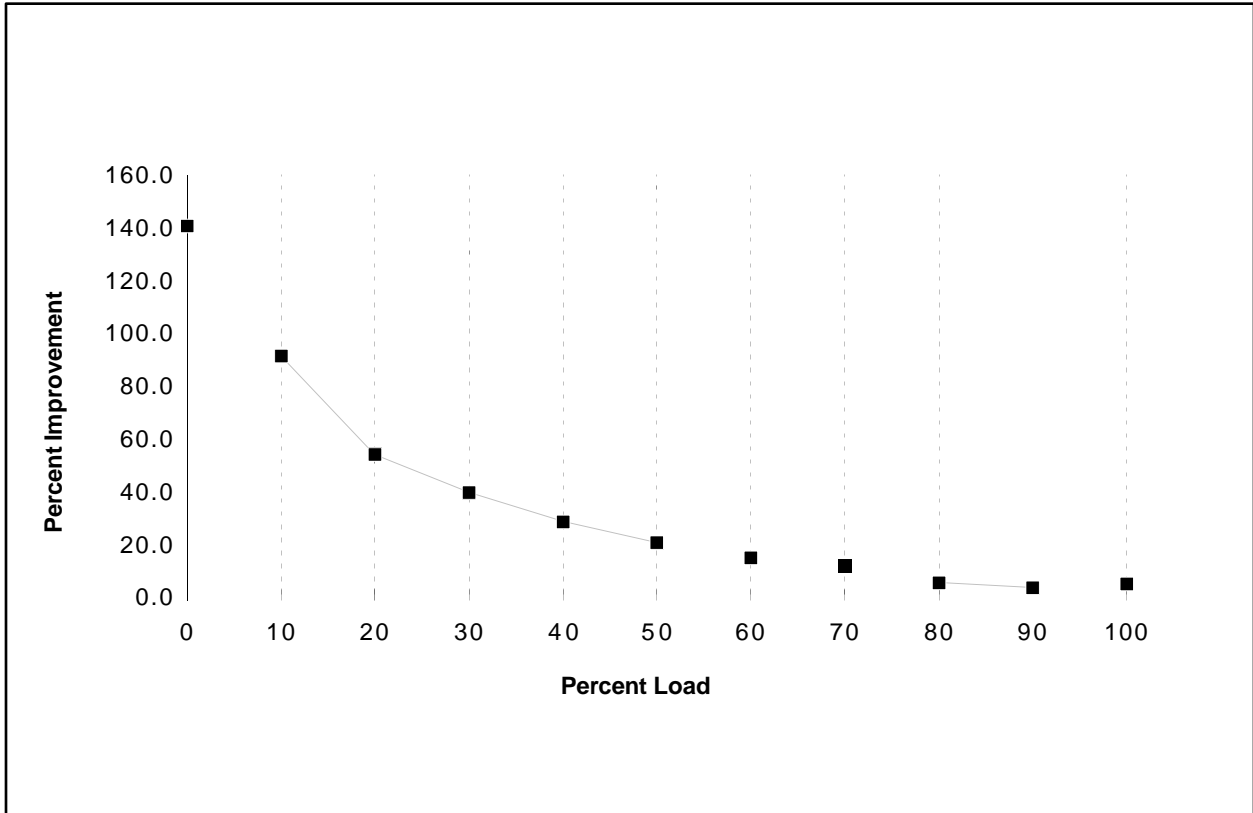

FIGURE 6: MOTOR CURRENT DRAW

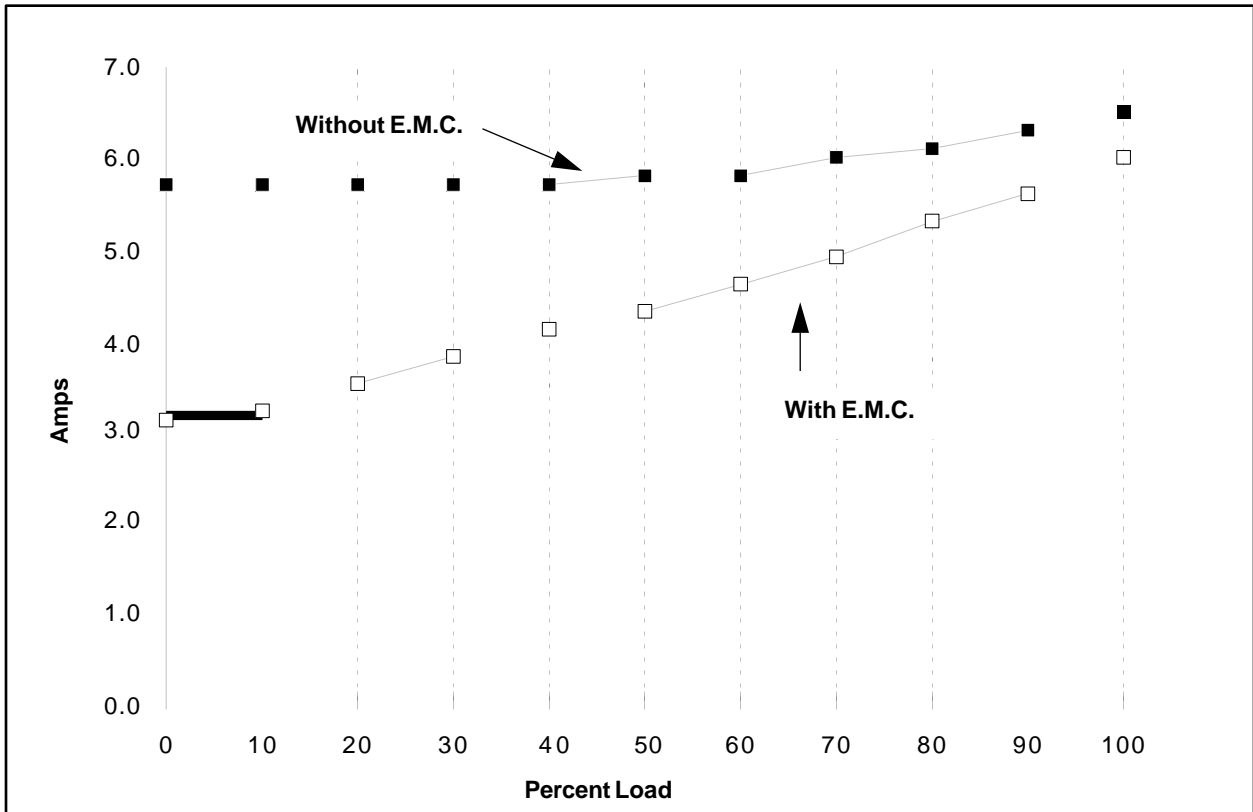

FIGURE 7: MOTOR POWER DRAW

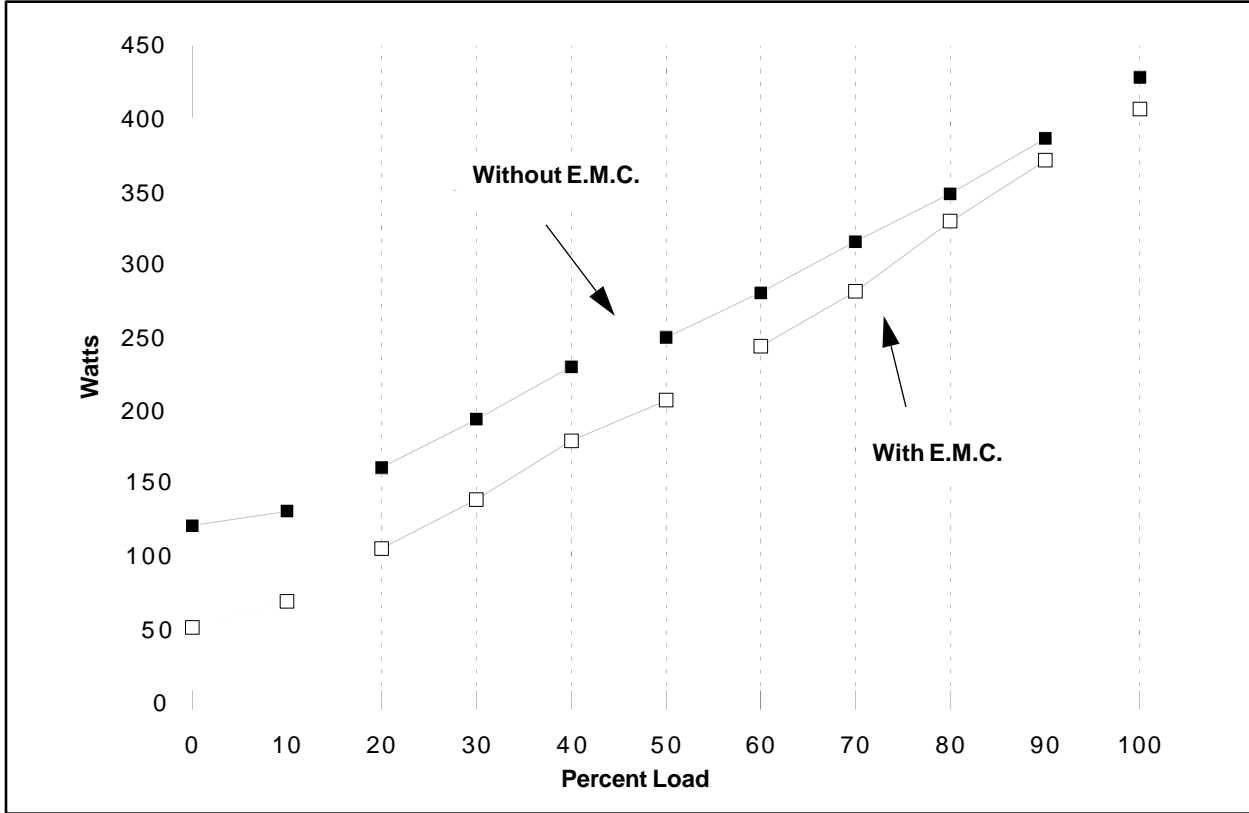

FIGURE 8: ENERGY SAVINGS FOR 1/4 HP MOTOR

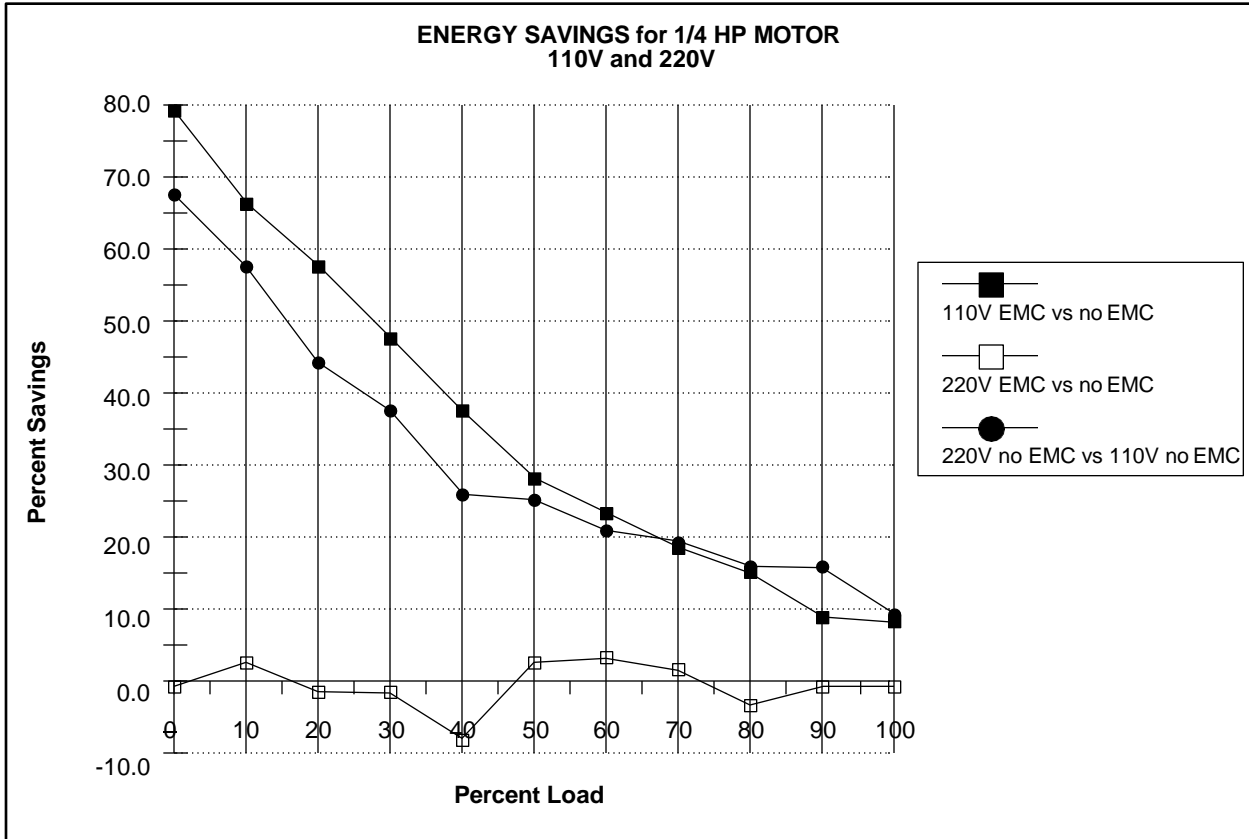

TABLE 1: OPERATING PARAMETER COMPARISONS

1/3 HP Motor without E.M.C.									
Load (%)	Load (Nm)	Vrms	Irms (A)	Power Factor	Power In (W)	RPM	Power Out (W)	Power Out (HP)	Efficiency (%)
0	0.00	115	5.7	0.18	120	1791	0	0.00	0.2
10	0.14	115	5.7	0.20	130	1788	26	0.04	20.1
20	0.29	115	5.7	0.24	160	1781	54	0.07	33.7
30	0.43	115	5.7	0.29	193	1777	80	0.11	41.4
40	0.57	115	5.7	0.35	229	1768	105	0.14	46.0
50	0.72	115	5.8	0.37	249	1764	133	0.18	53.3
60	0.86	115	5.8	0.42	280	1758	158	0.21	56.4
70	1.00	115	6.0	0.46	315	1750	183	0.25	58.0
80	1.14	116	6.1	0.49	348	1744	208	0.28	59.7
90	1.29	115	6.3	0.53	386	1736	234	0.31	60.6
100	1.43	116	6.5	0.57	428	1727	258	0.35	60.3

1/3 HP Motor with E.M.C.									
Load (%)	Load (Nm)	Vrms	Irms (A)	Power Factor	Power In (W)	RPM	Power Out (W)	Power Out (HP)	Efficiency (%)
0	0.00	113	3.1	0.14	50	1794	0	0.00	0.4
10	0.14	113	3.2	0.19	68	1786	26	0.04	38.4
20	0.29	113	3.5	0.26	104	1775	54	0.07	51.7
30	0.43	113	3.8	0.32	138	1764	79	0.11	57.4
40	0.57	113	4.1	0.38	178	1755	104	0.14	58.7
50	0.72	113	4.3	0.42	206	1749	132	0.18	63.8
60	0.86	112	4.6	0.47	243	1740	156	0.21	64.3
70	1.00	112	4.9	0.51	281	1730	181	0.24	64.3
80	1.14	112	5.3	0.55	329	1722	205	0.27	62.3
90	1.29	112	5.6	0.59	371	1713	231	0.31	62.2
100	1.43	111	6.0	0.61	406	1705	255	0.34	62.7

TABLE 2: ENERGY SAVINGS

LOAD (%)	Improvement in Efficiency (%)	Energy Savings (%)
0	140.4	58.3
10	91.0	47.7
20	53.3	35.0
30	38.8	28.5
40	27.7	22.3
50	19.8	17.3
60	14.0	13.2
70	10.8	10.8
80	4.4	5.5
90	2.7	3.9
100	4.1	5.1

FIGURE 9: WAVEFORMS

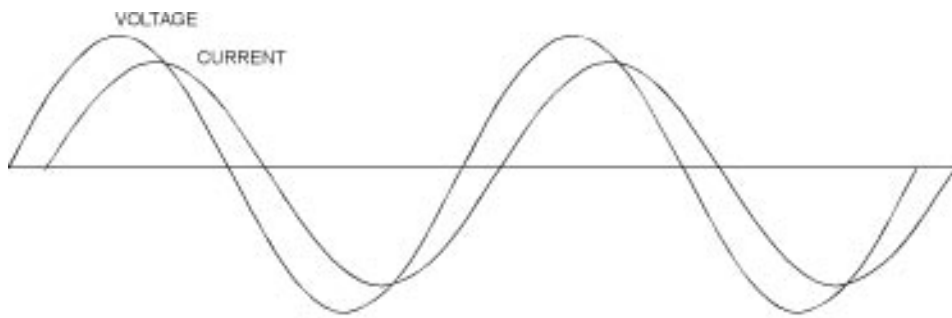

**MOTOR WAVEFORMS
NORMAL LINE CONNECTION**



FIGURE 10: EMC CIRCUIT WAVEFORMS

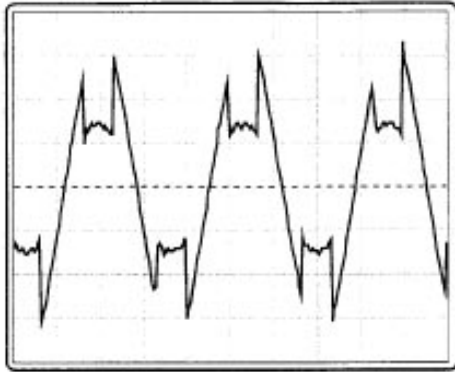

Form 1
LINE:NEUT
50V

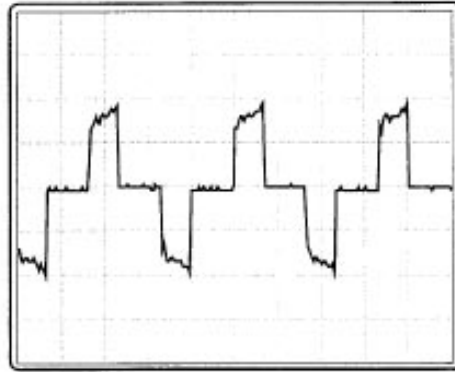

Form 5
LINE OUT
50V

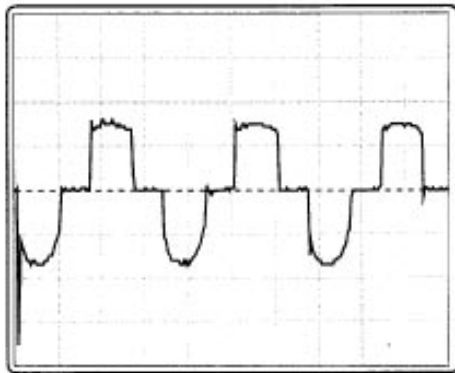

Form 2
U2:4
500mV

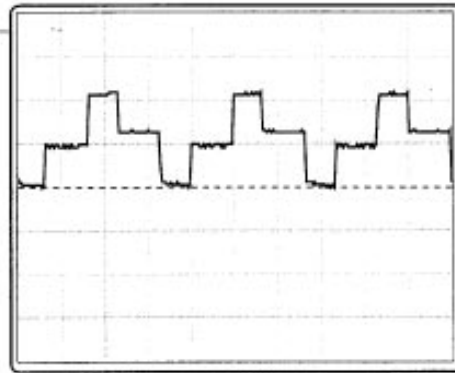

Form 6
U3:17
2V



Form 3
U3:7
2V

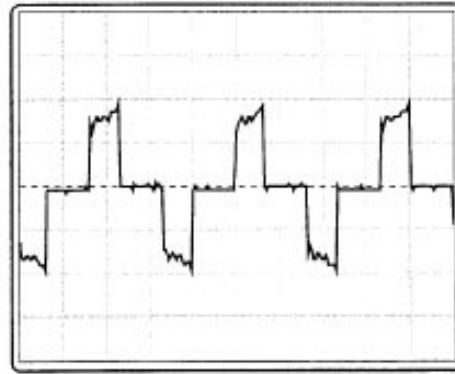

Form 7
U2:6
50V

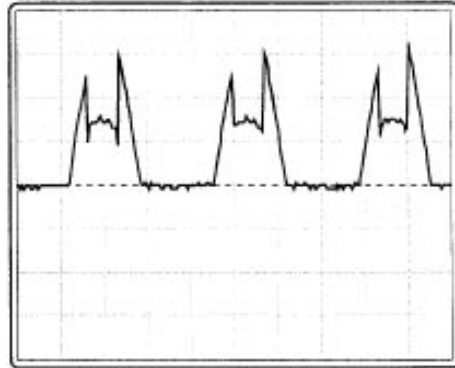

Form 4
U3:2
1V

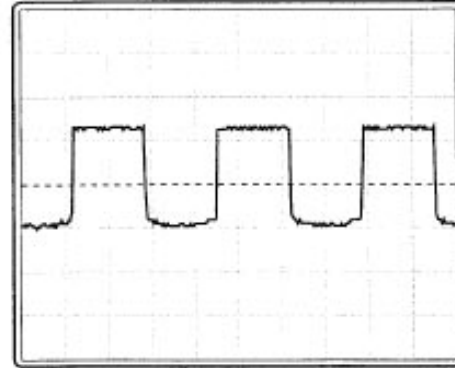

Form 8
Q2 BASE
500 mV

Note: Forms 2-8 ref'd to sig gnd. All are 5 ms per division. 110V line.

TABLE 3: BILL OF MATERIALS FOR ENERGY MANAGEMENT CONTROL DEMO BOARD

Item	Qty.	Reference	Value	Desc.ription		Mfg.
1	1	C1	100 μ F	16V	electrolytic	
2	1	C2	1 μ F	250VAC	film	
3	1	C3	220 μ F	16V	electrolytic	
4	2	C4,C5	100 pF		ceramic	
5	1	C6	0.1 μ F		ceramic	
6	1	C7	1 μ F	50V	electrolytic	
7	1	C8	2.2 μ F	250VAC	film	
8	2	C9,C10	0.1 μ F	250VAC	film	
9	3	D1,D2, D8	1N4007			
10	1	D3	LED	green		
11	1	D4	1N5226			
12	1	D5	1N4733			
13	2	D6,D7	1N5230			
14	1	L1	100 μ H		RF Choke	
15	1	Q1	TP2907			
16	1	Q2	TP2222A			
17	1	Q3	Q4015L5			
18	1	R1	470 1/2W			
19	1	R2	330 1/2W			
20	1	R3	560			
21	1	R4	270 1/2W			
22	2	R5, R15	30K			
23	1	R14	30K 1/2W			
24	1	R6	15K			
25	1	R7	560			
26	1	R8	2.4K			
27	1	R9	1M 1/2W			
28	2	R10,R13	562K 1%			
29	2	R11,R12	12.1K 1%			
30	1	R16	10K			
31	1	U1	TLC271CP	opamp		
32	1	U2	TLP3023	opto-triac		
33	1	U3	EMC			SAVEPLUG
34	1	Y1	4 MHz	ceramic resonator		
35	1			heatsink	as needed	

Note 1: C2,8,9,10 MUST be AC-rated capacitors. THIS IS CRUCIAL!

Note 2: Q3 can be sized to fit the load. A 400V 15A part is called out in the parts list and on the schematic; a 600V 25A part is also listed on the schematic for reference. Nearly any triac can be used here, as long as its trigger current does not exceed that supplied by U2 (typically 50 mA). For higher current applications, two SCR's back-to-back perform well. Performance is improved slightly if the device is NOT operated at its current limit.

Note 3: Any opto-triac meeting the current-transfer and current handling specs of the TLP3023 can be used.

Note 4: A heat sink is called out. Its size will depend on the particular Triac used, the operating temperature, and the load. Contact a heat sink manufacturer for specific information.

WORLDWIDE SALES & SERVICE

TURKIYE

Head.Corporate Office

Hamitler Mh. Recep Tayyip Erdoğan Bulvarı, Yunuseli TOKİ

Konutları, B1-9 Blok, D16 Osmangazi / BURSA / TURKEY

Tel: + 90 546 283 76 80 (Only Turkish)

Web: <http://www.saveplug.com>

Mail : info@saveplug.com

saveplug@hotmail.com

saveplug